

# Part Number: 1605ZZ

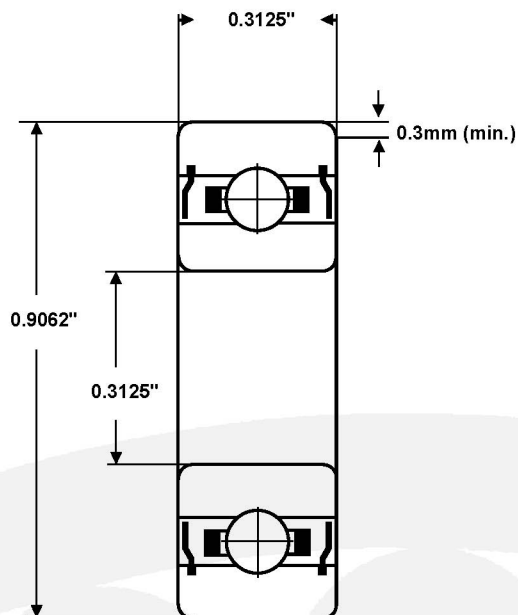

<b>Material (rings &amp; balls)</b>	SAE52100 chrome steel
<b>Material (cage)</b>	pressed steel
<b>Closures</b>	Metal shields
<b>Load rating (stat)</b>	135 Kgf
<b>Load rating (dyn)</b>	317 Kgf
<b>Speed Limit *</b>	31,000 rpm
<b>Standard Lubrication **</b>	Kyodo Yushi Multemp SRL grease

\* with adequate lubrication

\*\* may vary

**These bearings comply with EU ROHS and REACH regulations.**

RADIAL PLAY	MC1	MC2	MC3	MC4	MC5	MC6
(microns)	0 - 5	3 - 8	5 - 10	8 - 13	13 - 20	20 - 28

TOLERANCE	P0	P6	P5
<b>Bore Deviation</b>	+0 / -0.008mm	+0 / -0.007mm	+0 / -0.005mm
<b>OD Deviation</b>	+0 / -0.009mm	+0 / -0.008mm	+0 / -0.006mm
<b>Width Deviation</b>	+0 / -0.120mm	+0 / -0.120mm	+0 / -0.040mm
<b>Single Bore Variation</b>	8	7	4
<b>Single OD Variation</b>	9	8	5
<b>Inner Width Variation</b>	15	15	5
<b>Outer Width Variation</b>	15	15	5
<b>Inner Radial Runout</b>	10	6	4
<b>Outer Radial Runout</b>	15	9	6