

One Way Clutch Bearing

Part Number: **FC-30** with Roller & Stainless Steel Spring

Part Size: 30 x 37 x 20 mm

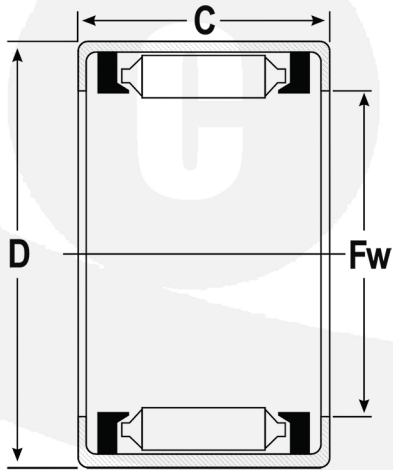

FW Inscribed circle diameter	30	mm
D Outer Diameter	37	mm
C Width	20	mm
TC Torque Capacities	95.12	Nm
TC1 Torque Capacities	9.700	fm
MASS Mass	42.0	
MODH Minimum Outside Diameters of Housing	51	mm
BGR1 Assembled Bearings (F.N.FH.BH)	F-3020	
BGR2 Assembled Bearings (FJ.J.FJH.JH)	FJ-3020	