

One Way Clutch Bearing

Part Number: **RC-081208** with plastic springs
 0.5000 x 0.7500 x 0.5000 inch

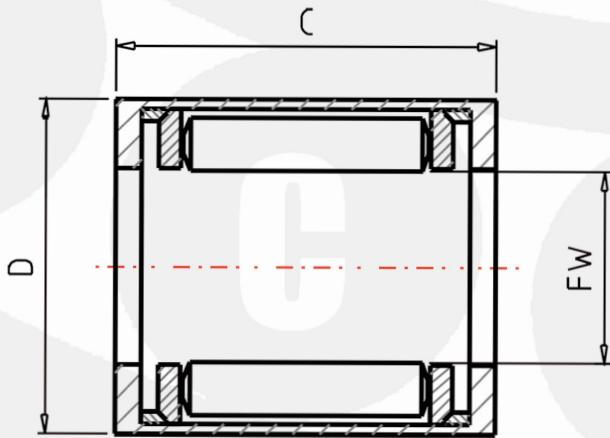

AISI52100 chrome Steel

FW Inscribed circle diameter	12.700	mm
D Outer Diameter	19.050	mm
C Width	12.70	mm
TC Torque Capacities	8.34	Nm
TC1 Torque Capacities	0.85	
MASS Mass	9.1	g
MODH Minimum Outside Diameters of Housing	28	mm
BGR1 Assembled Bearings (F.N.FH.BH)	BH-88	
BGR2 Assembled Bearings (F.J.J.FJH.JH)	JH-88	